



# Silo

Specification Guide

# Silo

The Silo table system expands upon the ingenious Blade hub system to provide unlimited table configurations using a flexible range of standard components. Sleek leg caps set against cylindrical steel legs offer the opportunity to mix and match a selection of stunning finishes to suit any office environment.

# Silo

## Tables

5 – 12

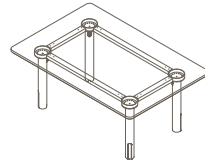

## Accessories

13

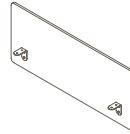

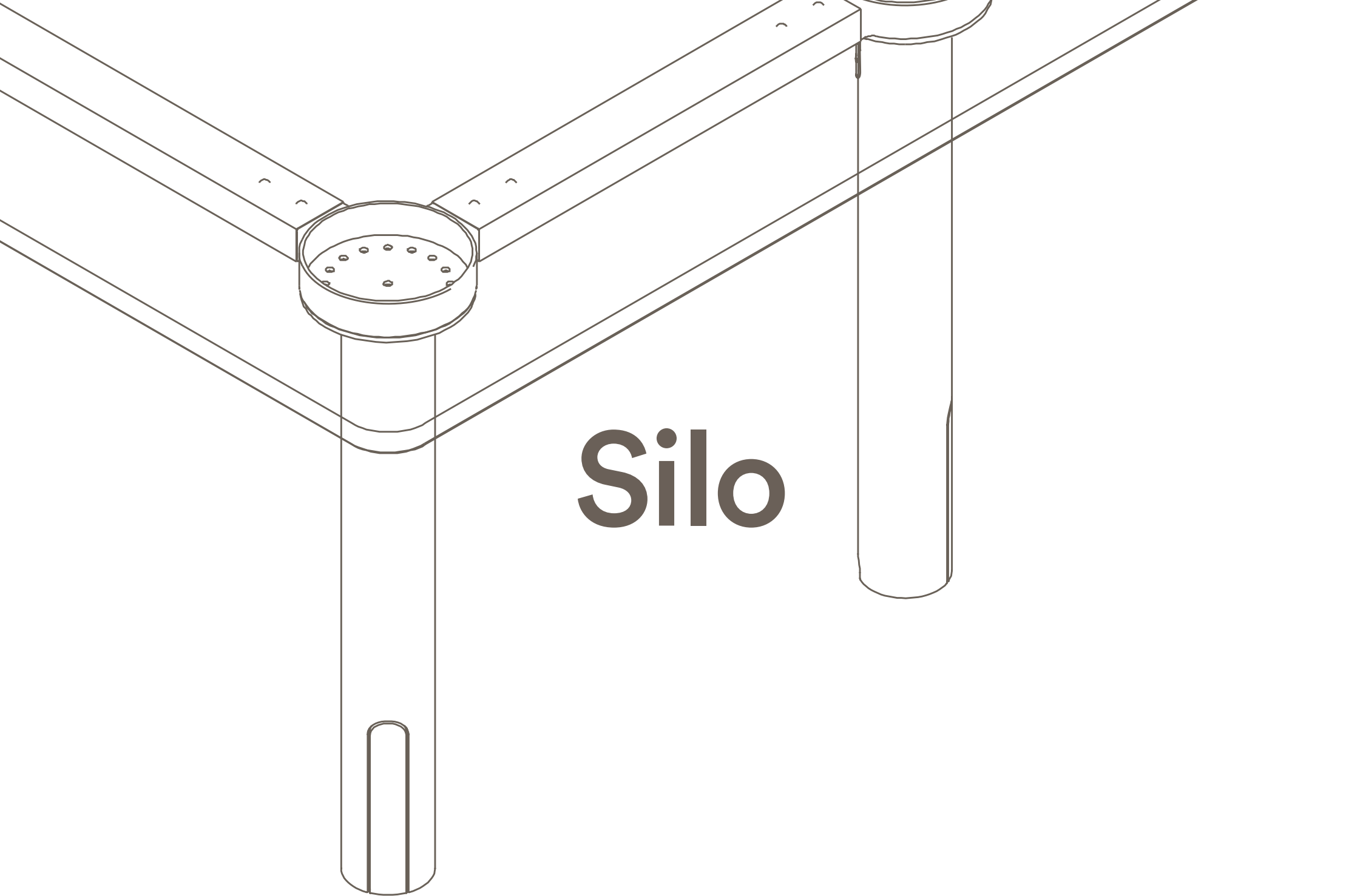

**Silo**

# Tables Finishes

## 1. Legs and Leg Cap

Silo legs and frame, made from steel and aluminium, are available in Blanc and Noir.

We offer premium Silo leg finishes in our current season powder coat colours. Silo is also available with Chrome plating and Oak Veneer.



## 2. Leg Cap Insert Finishes

We offer premium Silo Leg Cap insert finishes in our current season powder coat colours. The Silo Leg Cap inserts is also available in polished Aluminium and Oak Veneer.

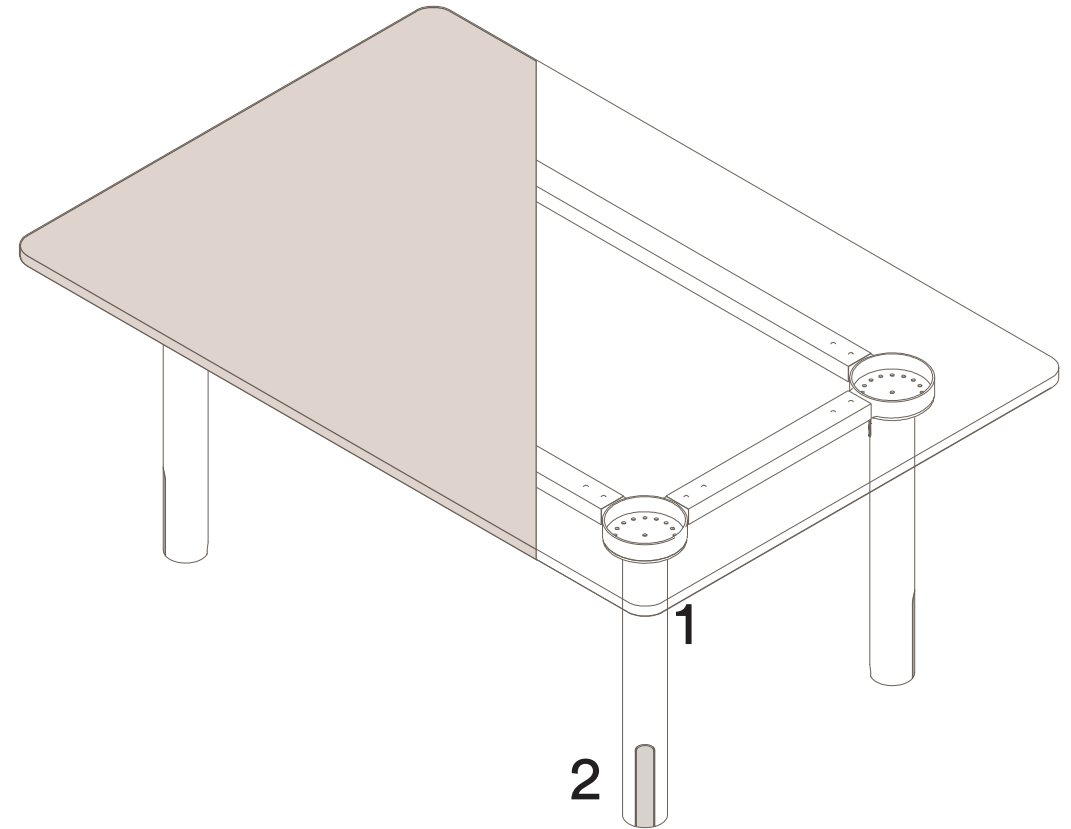

Colours are representative only, please check with your Thinking Works consultant to view samples of any specific colour and confirm availability in your country/region. Please note that pricing will vary based on your selected finish.

# Tables

## Round / Square

### Materials Information

Aluminium & Steel Frame

### Legs & Leg Cap

#### Standard Finishes

- a. Blanc Leg with Blanc Leg Cap
- b. Noir Leg with Noir Leg Cap

#### Seasonal Powder coat Finishes

- c. Axel Leg with Axel Leg Cap
- d. Folie Leg with Folie Leg Cap
- e. Green Smoke Leg with Green Smoke Leg Cap
- f. Minted Leg with Minted Leg Cap
- g. Nocturnelle Leg with Nocturnelle Leg Cap
- h. Pink Salt Leg with Pink Salt Leg Cap
- i. Scotland Sky Leg with Scotland Sky Leg Cap
- j. Zanilla Leg with Zanilla Cap

#### Premium Finishes

- k. Chrome Leg with Polished Aluminium Leg Cap
- l. Oak Veneer Leg with Powder-coated Leg Cap

### Contrasting Leg Cap

- a. Contrasting Powder coat
- b. Polished Aluminium
- c. Oak Veneer

Maximum inc. Worktop 160kg  
 Maximum Point Load 50kg  
 Seats 4 - 6

### RLD-1070

### 4 Leg - Timber Worktop

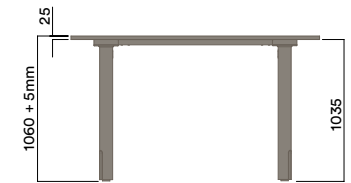
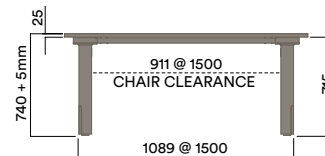
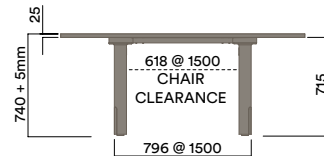
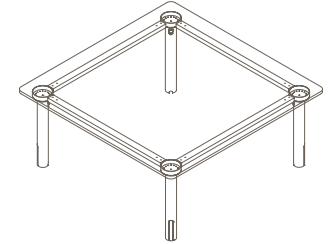
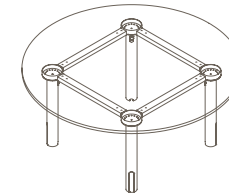
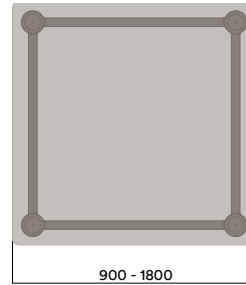
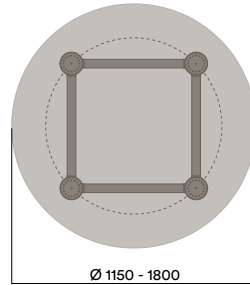

### RLG-1070

### 4 Leg - Glass Worktop

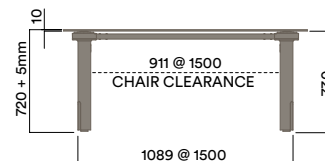
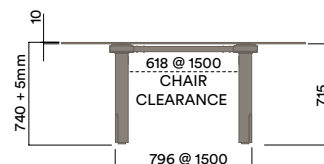
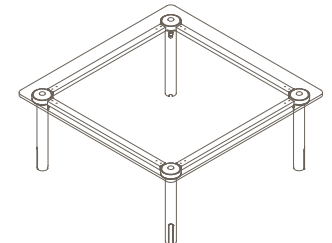
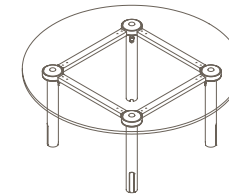
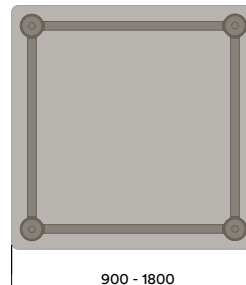
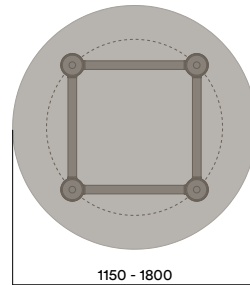

# Tables

## Round / Square

### Materials Information

Aluminium & Steel Frame

### Legs & Leg Cap

Standard Finishes

- a. Blanc Leg with Blanc Leg Cap
- b. Noir Leg with Noir Leg Cap

Seasonal Powder coat Finishes

- c. Axel Leg with Axel Leg Cap
- d. Folie Leg with Folie Leg Cap
- e. Green Smoke Leg with Green Smoke Leg Cap
- f. Minted Leg with Minted Leg Cap
- g. Nocturnelle Leg with Nocturnelle Leg Cap
- h. Pink Salt Leg with Pink Salt Leg Cap
- i. Scotland Sky Leg with Scotland Sky Leg Cap
- j. Zanilla Leg with Zanilla Cap

Premium Finishes

- k. Chrome Leg with Polished Aluminium Leg Cap
- l. Oak Veneer Leg with Powder-coated Leg Cap

### Contrasting Leg Cap

- a. Contrasting Powder coat
- b. Polished Aluminium
- c. Oak Veneer

Maximum inc. Worktop 80kg  
 Maximum Point Load 30kg  
 Seats 4 - 6

### RLD-1015

### 4 Leg Freestanding

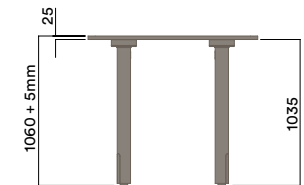
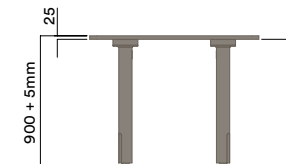
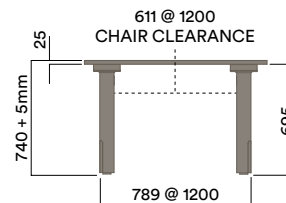
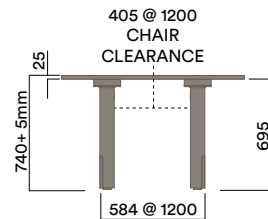
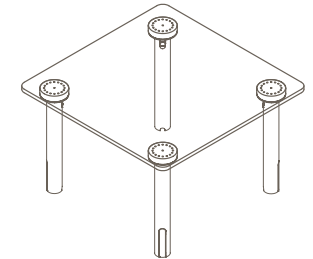
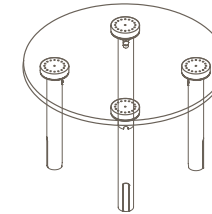
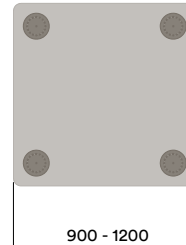
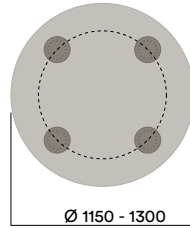

### RLD-1072

### 4 Leg - 2pc Worktop

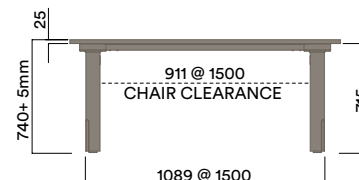
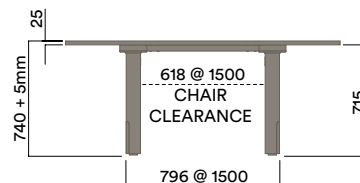
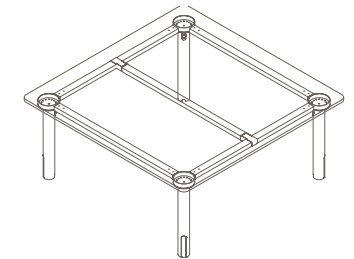
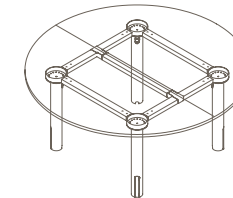
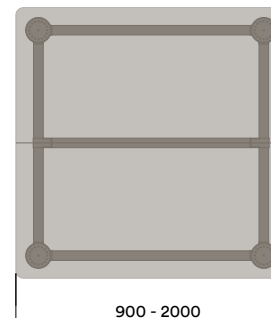
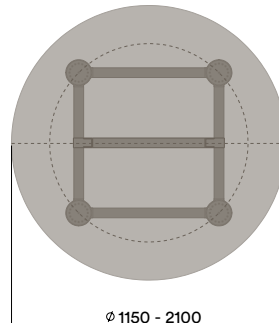

# Tables Triangle

## Materials Information

Aluminium & Steel Frame

### Legs & Leg Cap

#### Standard Finishes

- Blanc Leg with Blanc Leg Cap
- Noir Leg with Noir Leg Cap

#### Seasonal Powder coat Finishes

- Axel Leg with Axel Leg Cap
- Folie Leg with Folie Leg Cap
- Green Smoke Leg with Green Smoke Leg Cap
- Minted Leg with Minted Leg Cap
- Nocturnelle Leg with Nocturnelle Leg Cap
- Pink Salt Leg with Pink Salt Leg Cap
- Scotland Sky Leg with Scotland Sky Leg Cap
- Zanilla Leg with Zanilla Cap

#### Premium Finishes

- Chrome Leg with Polished Aluminium Leg Cap
- Oak Veneer Leg with Powder-coated Leg Cap

### Contrasting Leg Cap

- Contrasting Powder coat
- Polished Aluminium
- Oak Veneer

Maximum inc. Worktop 60kg  
 Maximum Point Load 30kg  
 Seats 1-3

RLD-1060

3 Leg Free Standing

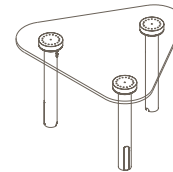
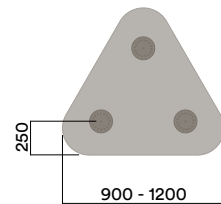

RLD-1062

3 Leg - Timber Worktop

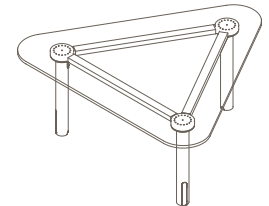
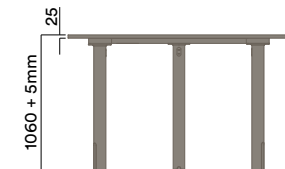
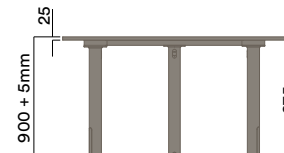
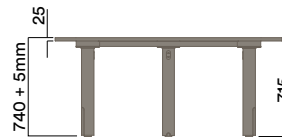
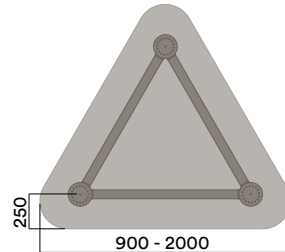

RLG-1062

3 Leg - Glass Worktop

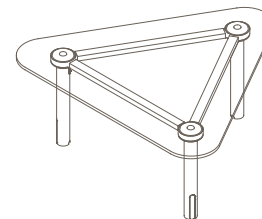
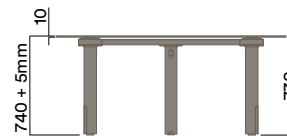
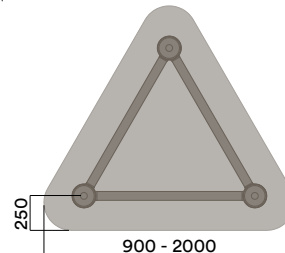



# Tables

## Rectangle

### Materials Information

Aluminium & Steel Frame

### Legs & Leg Cap

#### Standard Finishes

- a. Blanc Leg with Blanc Leg Cap
- b. Noir Leg with Noir Leg Cap

#### Seasonal Powder coat Finishes

- c. Axel Leg with Axel Leg Cap
- d. Folie Leg with Folie Leg Cap
- e. Green Smoke Leg with Green Smoke Leg Cap
- f. Minted Leg with Minted Leg Cap
- g. Nocturnelle Leg with Nocturnelle Leg Cap
- h. Pink Salt Leg with Pink Salt Leg Cap
- i. Scotland Sky Leg with Scotland Sky Leg Cap
- j. Zanilla Leg with Zanilla Cap

#### Premium Finishes

- k. Chrome Leg with Polished Aluminium Leg Cap
- l. Oak Veneer Leg with Powder-coated Leg Cap

### Contrasting Leg Cap

- a. Contrasting Powder coat
- b. Polished Aluminium
- c. Oak Veneer

Maximum inc. Worktop 160kg  
 Maximum Point Load 50kg  
 Seats 4 - 6

### RLD-1050 4 Leg - Timber Worktop Table

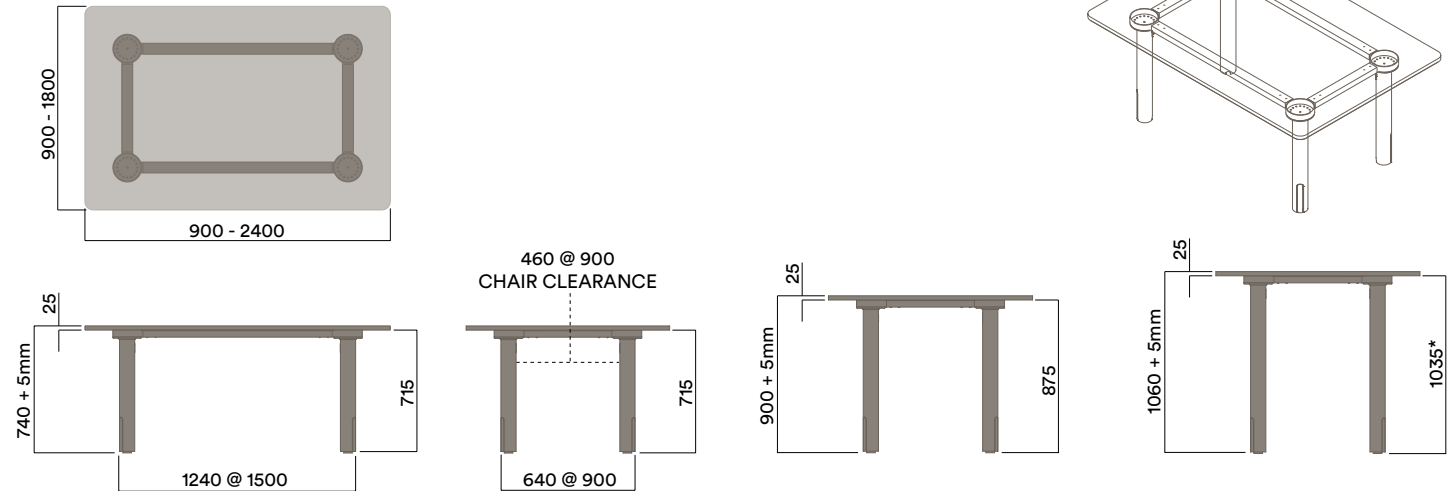

### RLD-1050 4 Leg - Glass Worktop



# Tables

## Rectangle

### Materials Information

Aluminium & Steel Frame

### Legs & Leg Cap

Standard Finishes

- Blanc Leg with Blanc Leg Cap
- Noir Leg with Noir Leg Cap

Seasonal Powder coat Finishes

- Axel Leg with Axel Leg Cap
- Folie Leg with Folie Leg Cap
- Green Smoke Leg with Green Smoke Leg Cap
- Minted Leg with Minted Leg Cap
- Nocturnelle Leg with Nocturnelle Leg Cap
- Pink Salt Leg with Pink Salt Leg Cap
- Scotland Sky Leg with Scotland Sky Leg Cap
- Zanilla Leg with Zanilla Cap

Premium Finishes

- Chrome Leg with Polished Aluminium Leg Cap
- Oak Veneer Leg with Powder-coated Leg Cap

### Contrasting Leg Cap

- Contrasting Powder coat
- Polished Aluminium
- Oak Veneer

\* Inset legs available for Silo Multi-Leg frames

Maximum inc. Worktop	240kg
Maximum Point Load	50kg
Seats	4 - 16

RLD-1052 - 8 Legs

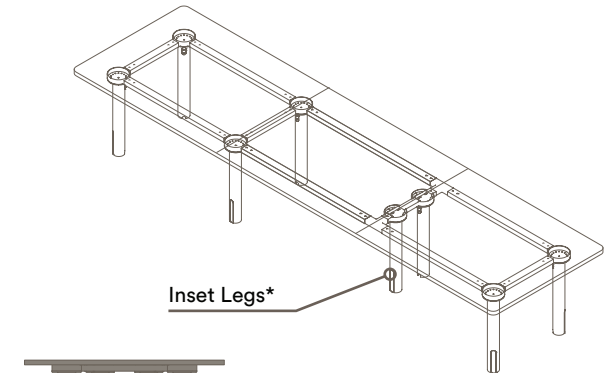
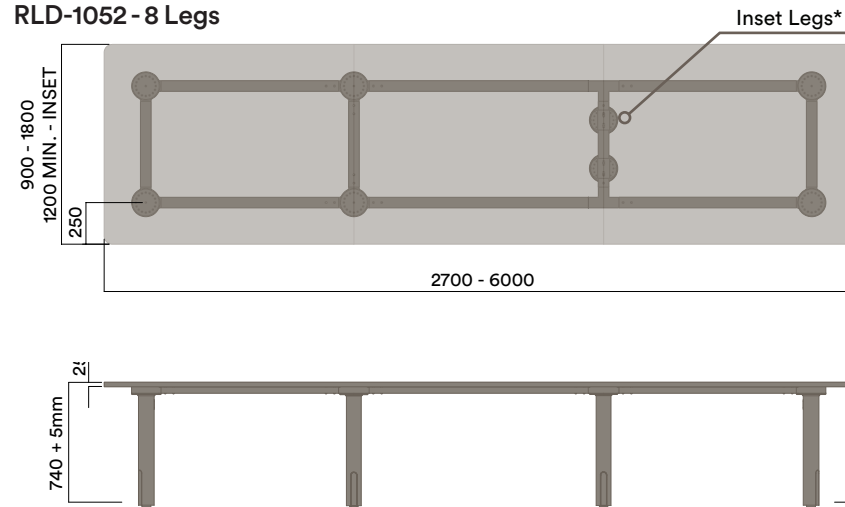

RLD-1051 - 6 Legs

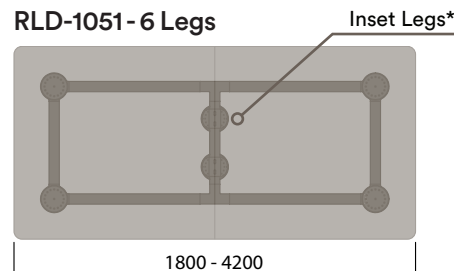

RLD-1053 - 10 Legs

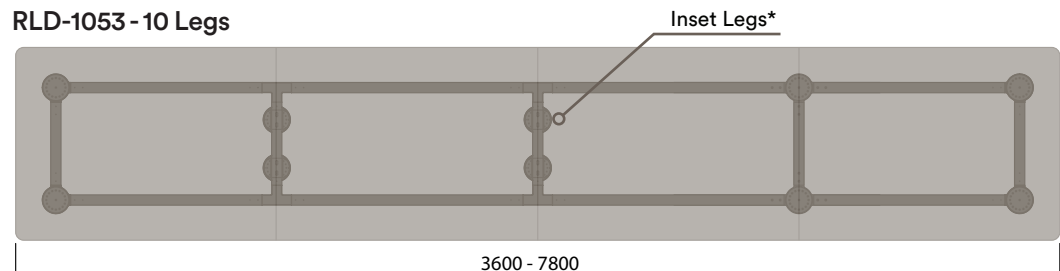

RLD-1054 - 12 Legs

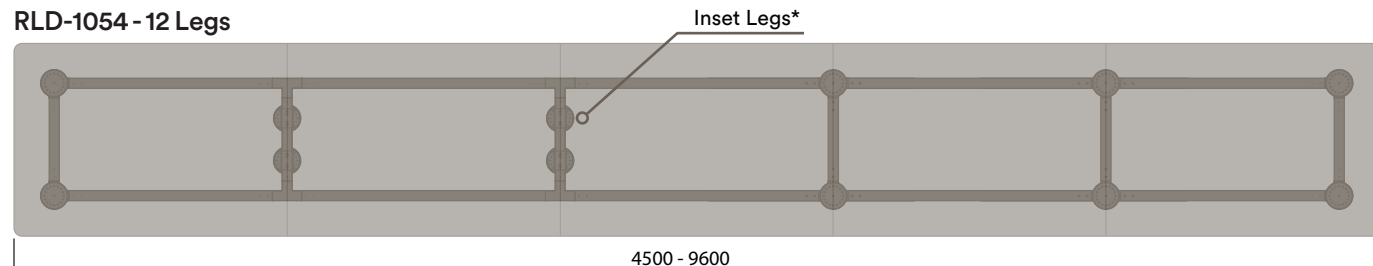

# Tables Adjustable

## Materials Information

Aluminium & Steel Frame

## Legs & Leg Cap

Standard Finishes

- Blanc Leg with Blanc Leg Cap
- Noir Leg with Noir Leg Cap

Seasonal Powder coat Finishes

- Axel Leg with Axel Leg Cap
- Folie Leg with Folie Leg Cap
- Green Smoke Leg with Green Smoke Leg Cap
- Minted Leg with Minted Leg Cap
- Nocturnelle Leg with Nocturnelle Leg Cap
- Pink Salt Leg with Pink Salt Leg Cap
- Scotland Sky Leg with Scotland Sky Leg Cap
- Zanilla Leg with Zanilla Cap

Premium Finishes

- Chrome Leg with Polished Aluminium Leg Cap
- Oak Veneer Leg with Powder-coated Leg Cap

## Contrasting Leg Cap

- Contrasting Powder coat
- Polished Aluminium
- Oak Veneer

\* Inset legs available for Silo Multi-Leg frames

Maximum inc. Worktop	160kg
Maximum Point Load	50kg
Seats	4 - 6

## RLA-1050 Adjustable Hub Frame

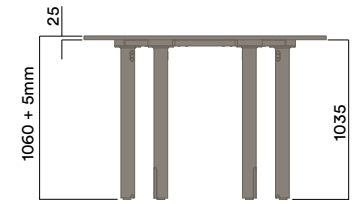
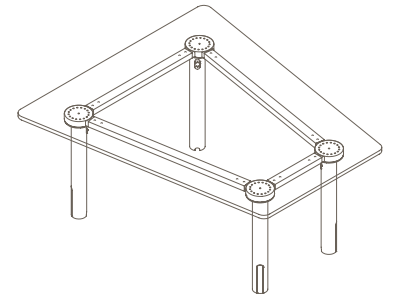
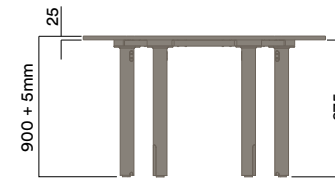
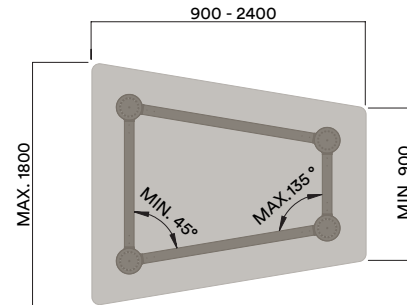

## RLA-1050 4 Leg

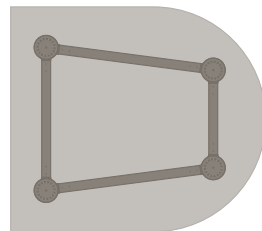

## RLA-1052 8 Leg

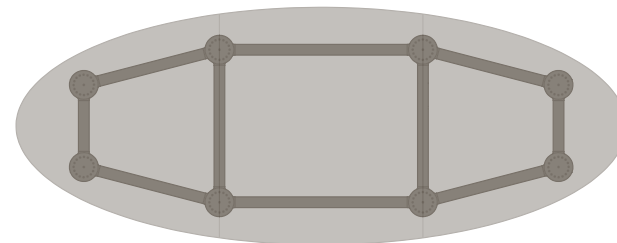

## RLA-1051 6 Leg

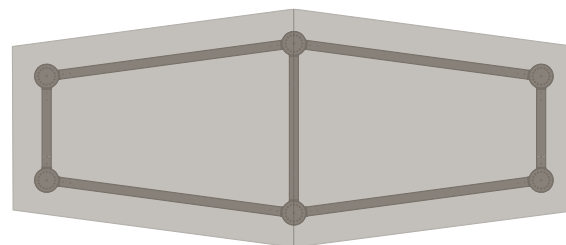

## RLA-1053 10 Leg

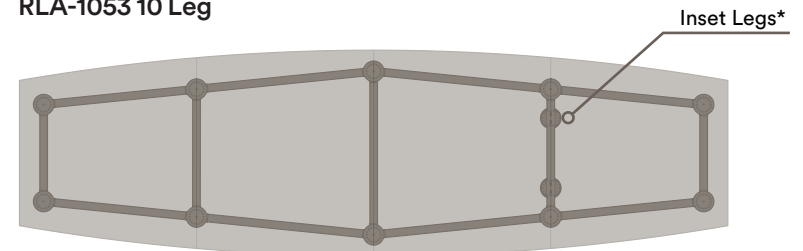

# Tables On Castors

## Materials Information

Aluminium & Steel Frame

### Legs & Leg Cap

#### Standard Finishes

- a. Blanc Leg with Blanc Leg Cap
- b. Noir Leg with Noir Leg Cap

#### Seasonal Powder coat Finishes

- c. Axel Leg with Axel Leg Cap
- d. Folie Leg with Folie Leg Cap
- e. Green Smoke Leg with Green Smoke Leg Cap
- f. Minted Leg with Minted Leg Cap
- g. Nocturnelle Leg with Nocturnelle Leg Cap
- h. Pink Salt Leg with Pink Salt Leg Cap
- i. Scotland Sky Leg with Scotland Sky Leg Cap
- j. Zanilla Leg with Zanilla Cap

#### Premium Finishes

- k. Chrome Leg with Polished Aluminium Leg Cap
- l. Oak Veneer Leg with Powder-coated Leg Cap

### Contrasting Leg Cap

- a. Contrasting Powder coat
- b. Polished Aluminium
- c. Oak Veneer

\* MOQ & Lead-time applies

Maximum inc. Worktop	160kg
Maximum Point Load	50kg
Seats	4 - 6

## RLD-1050-CA

### 4 Leg - on Castors

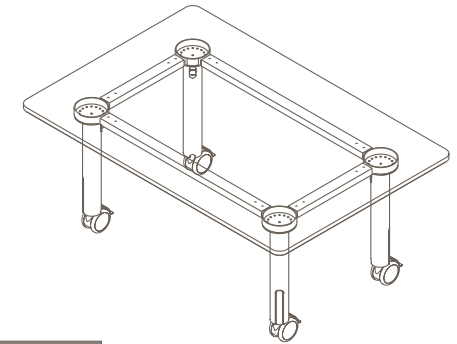
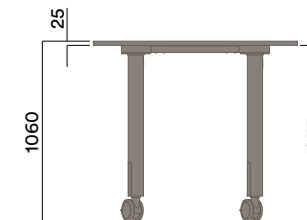
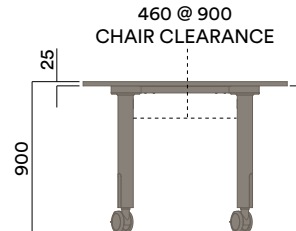
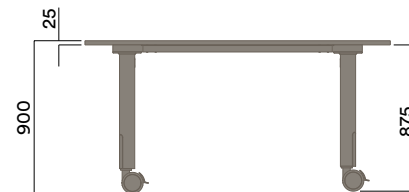
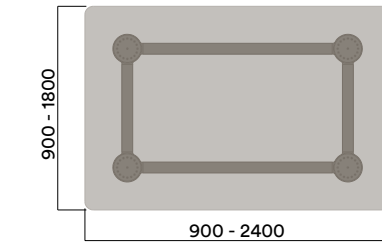

## RLA-1050

### 4 Leg - on Castors

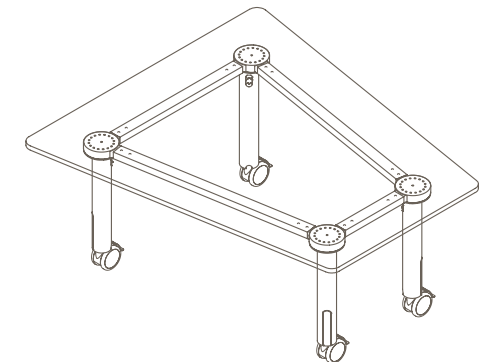
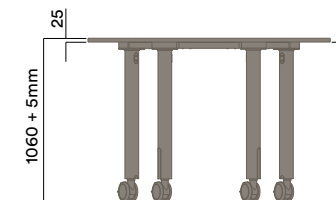
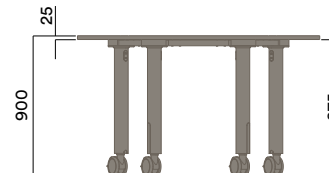
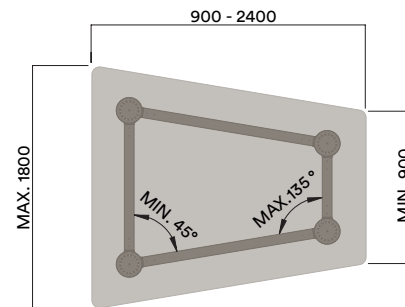

# Tables

## Mezzanine

### Materials Information

Aluminium & Steel Frame

### Legs & Leg Cap

#### Standard Finishes

- a. Blanc Leg with Blanc Leg Cap
- b. Noir Leg with Noir Leg Cap

#### Seasonal Powder coat Finishes

- c. Axel Leg with Axel Leg Cap
- d. Folie Leg with Folie Leg Cap
- e. Green Smoke Leg with Green Smoke Leg Cap
- f. Minted Leg with Minted Leg Cap
- g. Nocturnelle Leg with Nocturnelle Leg Cap
- h. Pink Salt Leg with Pink Salt Leg Cap
- i. Scotland Sky Leg with Scotland Sky Leg Cap
- j. Zanilla Leg with Zanilla Cap

#### Premium Finishes

- k. Chrome Leg with Polished Aluminium Leg Cap
- l. Oak Veneer Leg with Powder-coated Leg Cap

### Contrasting Leg Cap

- a. Contrasting Powder coat
- b. Polished Aluminium
- c. Oak Veneer

Maximum inc. Worktop 160kg  
 Maximum Point Load 50kg  
 Seats 4 - 6

**RLD-1051-MZ 6 Leg - Mezzanine Table**

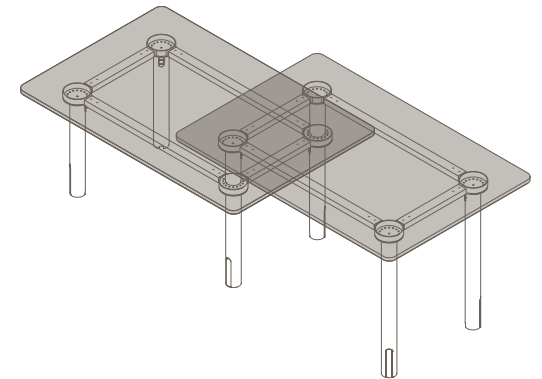
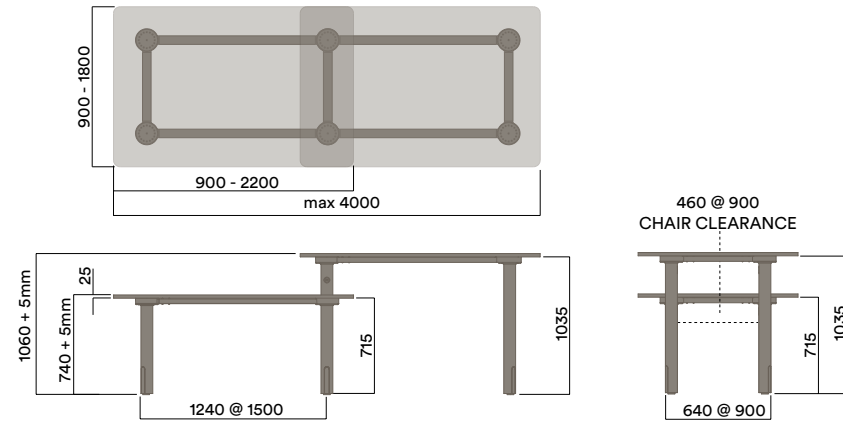

**RLA-1051-MZ 6 Leg - Mezzanine Table**

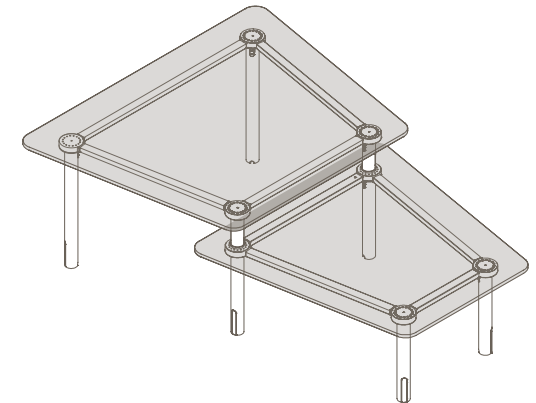
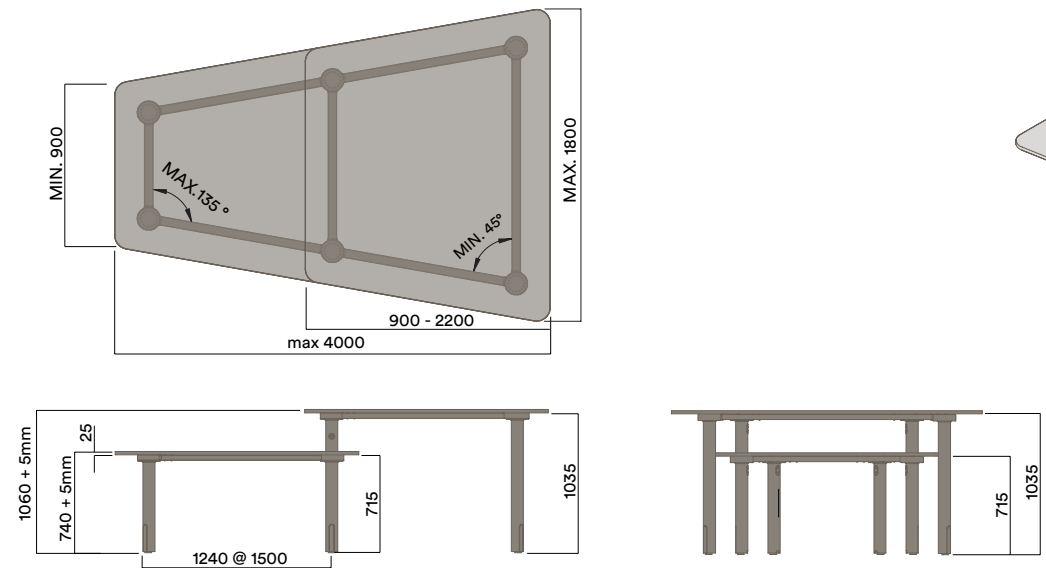

# Accessories

## PET Mezzanine Modesty

### Materials Information

RL-8200 Series

PET Modesty Screen

#### Acoustic Screen

PET Modesty Panel

- a. Light Grey
- b. Dark Grey

#### Modesty Mounts

Powder coat Mount

- a. Noir
- b. Blanc
- c. Other Colour

WORKTOP WIDTH	SCREEN LENGTH
1000-1200	900
1201-1400	1100
1401-1600	1300
1601-1800	1500

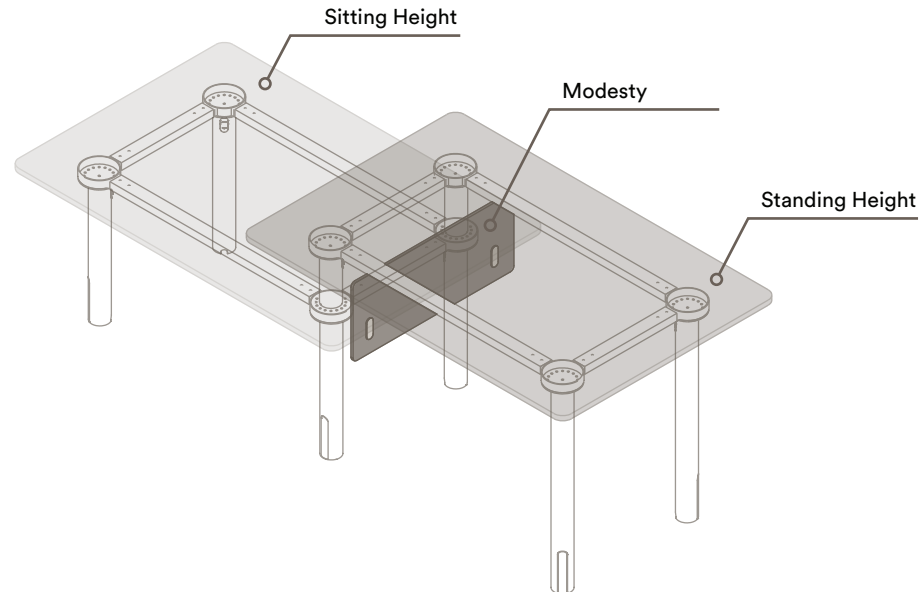
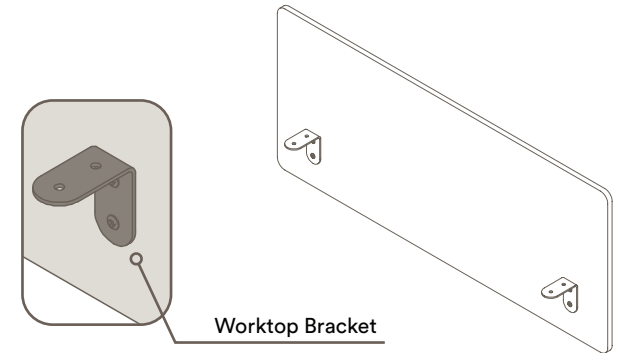
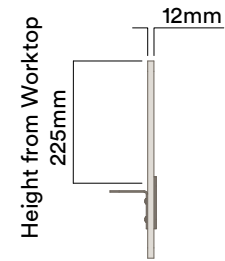
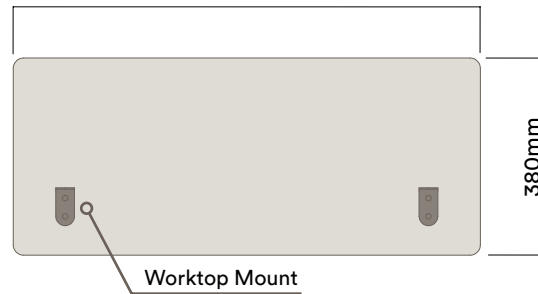

# Accessories

## Power Pocket

### Materials Information

#### Power Pocket Lid

Powder coat Steel

- Noir
- Blanc
- Other Colour

#### Power Pocket Bracket

Powder coat Steel

- Noir

#### Fabric Cable Pocket

Fabric

- Light Grey

#### Power options for different countries available:

- 4 x Power & 2 x Data (AUS)
- 6 x Power (AUS)
- 4 x Power & 2 x Data (UK)
- 6 x Power (UK)

RL-8050

Powerbox

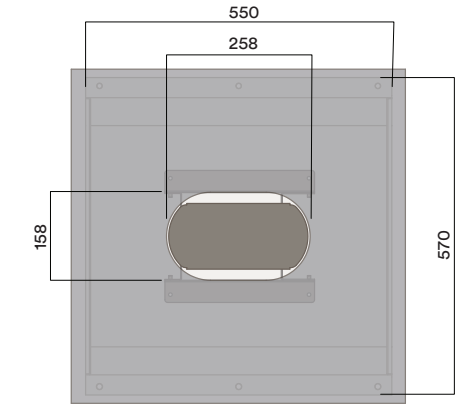
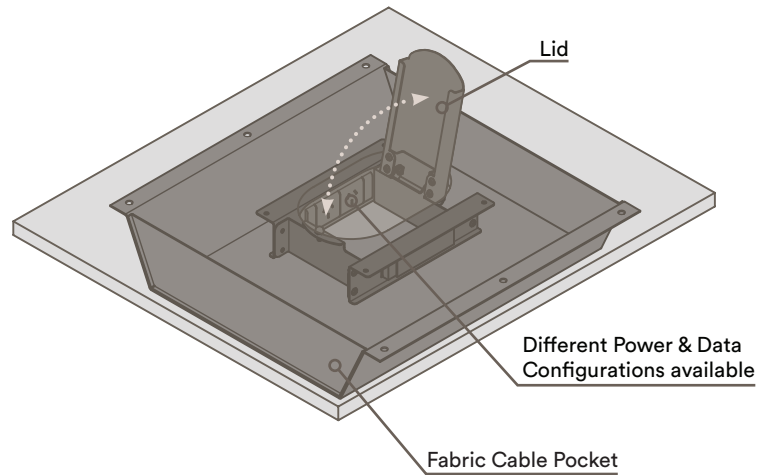

Cut-out in Worktop

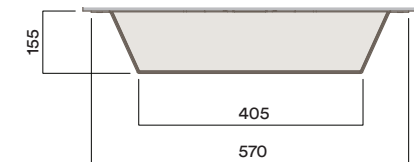

#### Power & Data Configurations:

Powerbox has 2x 236 x 41.5 cut-outs and is compatible to a wide range of CMS Products:

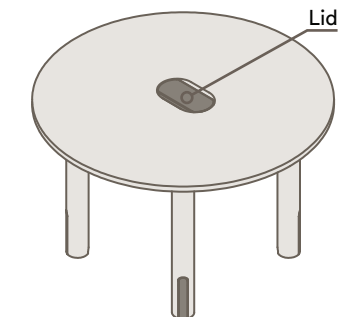
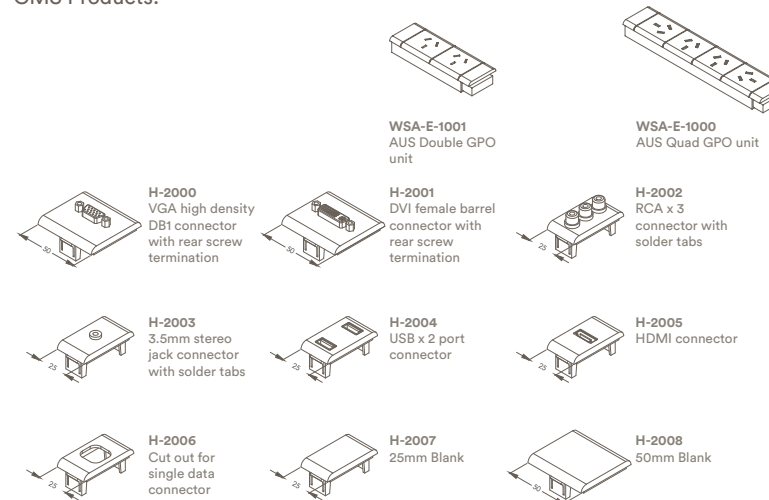

# Accessories Powerbox

## Materials Information

### Power Pocket Lid

Powder coat Steel

- Noir
- Blanc
- Other Colour

### Power Pocket Bracket

Powder coat Steel

- Noir

### Fabric Cable Pocket

Fabric

- Light Grey

### Power options for different countries available:

- 4 x Power & 2 x Data (AUS)
- 6 x Power (AUS)
- 4 x Power & 2 x Data (UK)
- 6 x Power (UK)

RL-8051

Powerbox

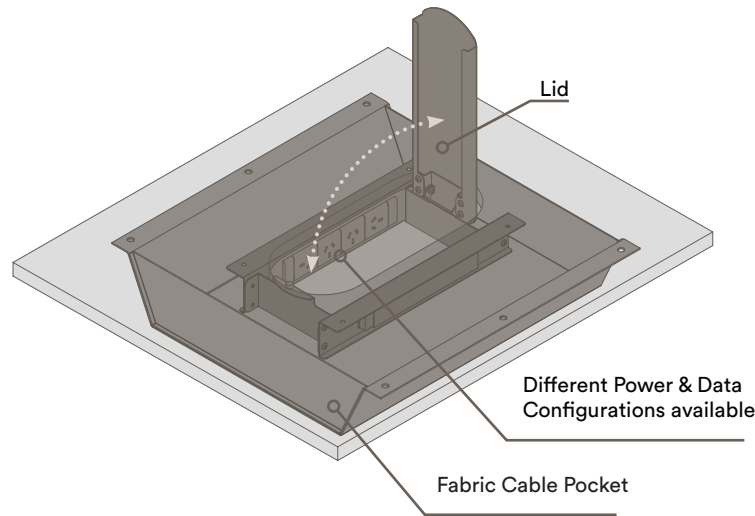

### Power & Data Configurations:

Powerbox has 2x 236 x 41.5 cut-outs and is compatible to a wide range of CMS Products:

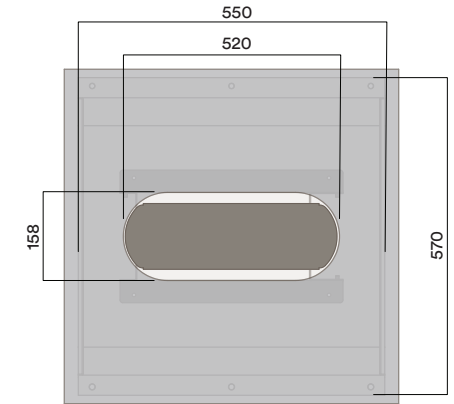
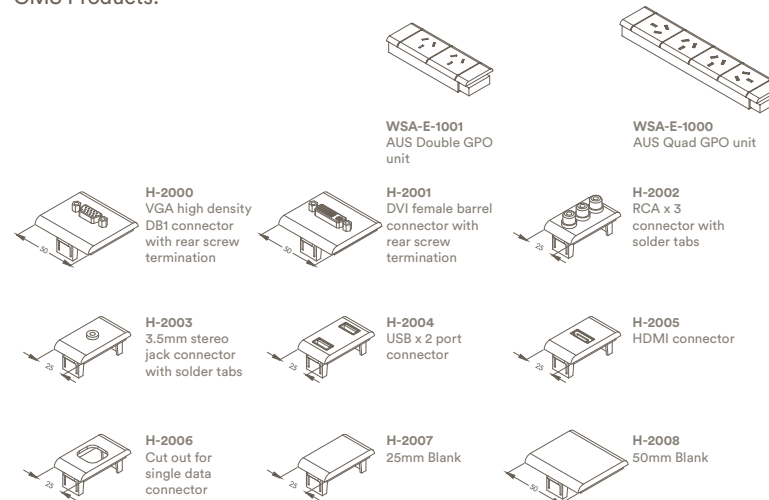

Cut-out in Worktop

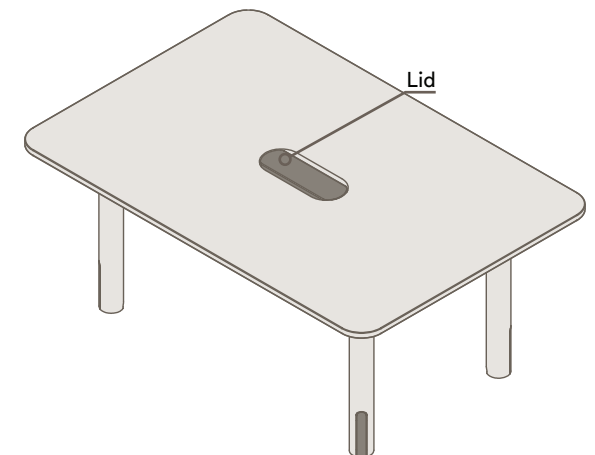
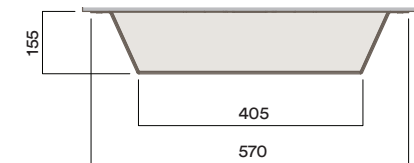



# Accessories

## Power Data Socket

### Materials Information

#### Power Data Socket

ABS Plastics

a. Matt Black

#### Power options available:

##### a. USB-A - 15W Output

Charges Smartphones & Tablets  
Fast Charge delivery for Fast Charge compatible devices .

##### b. USB-C - 15W Output

Charges Smartphones & Tablets  
Fast Charge delivery for Fast Charge compatible devices.

##### b. USB-C - 61W Output

Charges Laptop, Smartphones & Tablets.  
Fast Charge delivery for Fast Charge compatible devices.

Device must compatible with charging from 61W power adapter.

##### c. HDMI

For Display and Audio Mirroring further hardware required and not supplied.



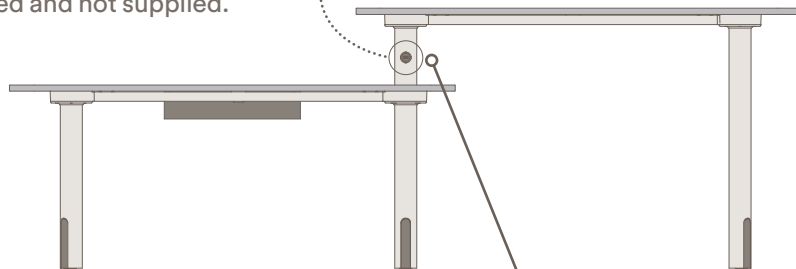
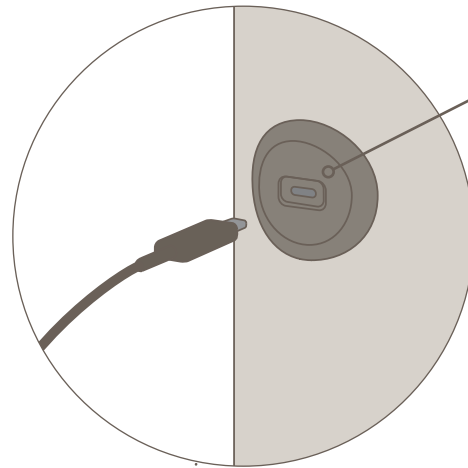









### Agile Working



Sockets are standard in leg raiser of Mezzanine Table

### Endless Opportunities

#### Socket Options and Specifications:

	a.	USB-A 3.0 Socket	Power Output: DC 5V/3A, 9V/2A, 12V/1.5A Quick Charge	 
	b.	USB-C 3.1 Socket	Power Output: DC 5V/3A, 9V/2A, 12V/1.5A Quick Charge	 
	c.	USB-C 3.1 Socket	Power Output: 5V~20.3V / 3A (max) USB PD/QC 3.0	 
	d.	HDMI 3.1 Socket	Data Transfer: Up to 18 Gbit/s	 

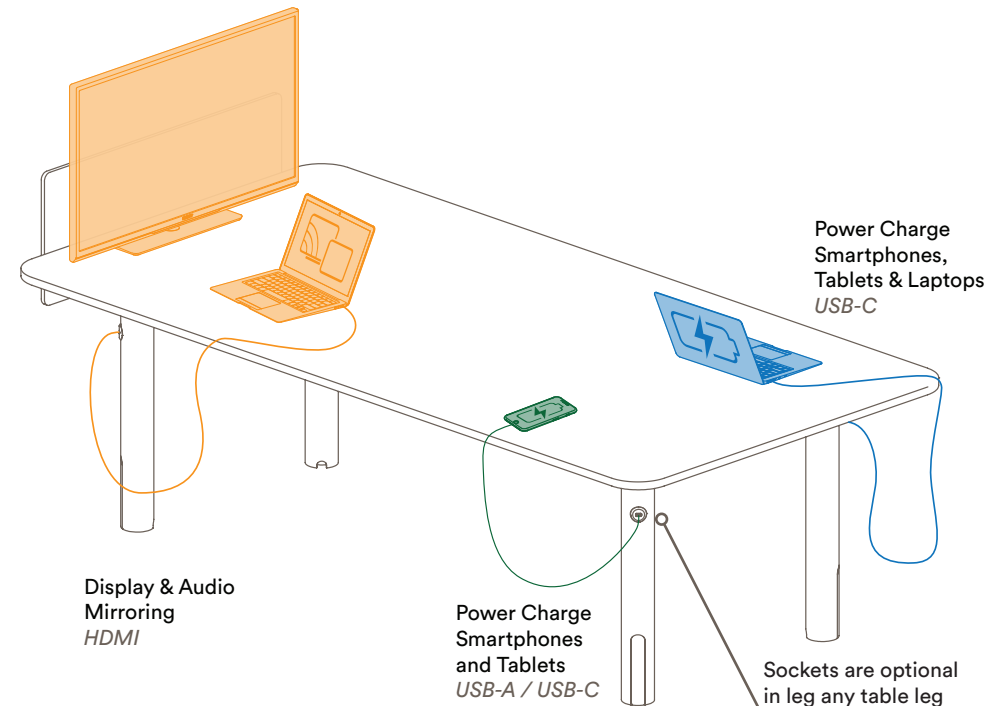



## **Specification**

If you would like a sample set of any of our finishes, please call us on 61 (0)2 9726 7177 or e-mail at [sales@thinkingw.com](mailto:sales@thinkingw.com).

Due to our policy of continuous product development, specifications and finishes may change without prior notice.

## **Sustainability Policy**

We realise the importance of responsible business practices and have in place numerous product and company sustainability certifications. We would encourage you to download our annual Sustainability Report from the Thinking Works website to get a full overview of our sustainability program.

Thinking Works  
© Copyright 2020  
All right reserved

Thinking Works  
25 Helles Avenue  
Moorebank  
New South Wales 2170

[www.thinkingw.com](http://www.thinkingw.com)  
61 (0)2 9726 7177  
[sales@thinkingw.com](mailto:sales@thinkingw.com)